

L7224A,C; L7248A,C,L Oil Electronic AquaStat® Controllers

INSTALLATION INSTRUCTIONS

APPLICATION

The L7224A,C and L7248A,C,L Oil Electronic AquaStat® Controllers provide electronic temperature sensing in a UL limit-rated control with a single sensing probe. The L7224A,C and L7248A,C,L control the circulator, oil burner and boiler temperature. The L7224/L7248 is "Outdoor Temperature Reset" ready which is enabled when connected to the 50022037-002 Outdoor Reset Module.

The L7224A,C and L7248A,C,L replace the L8124A, L8124C, L7124A,C, L7148A and L8148A Controllers. The L7224A,C and L7248A,C,L series of controls provide status and diagnostic information through an LED display combined with LED lights as well as EnviraCOM™ enabled thermostats and diagnostic tools to enhance the diagnostic process.

These AquaStat Controllers are intended for use in residential-type applications.

SPECIFICATIONS

Electrical Ratings:

Voltage: 120 Vac, 60 Hz.
Power: 7 VA maximum at 120 Vac plus external loads.
Thermostat current: 100 mA nominal at 24 Vac.
Burner Relay:

7.4 A at 120 Vac Full Load Amperage (FLA);
44.4 A inrush Locked Rotor Amperage (LRA);
Less Ignition Load: 360 VA.

Circulator Relay:

7.4 A at 120 Vac FLA; 44.4 A inrush LRA.
Zone Controller (ZC): 7.4 A at 120 Vac FLA;
44.4 A inrush LRA.

NOTE: All loads combined cannot exceed 2000 VA.

Environmental Ratings:

Temperature: -30° F to +150° F (-34° C to +66° C).
Humidity: 0 to 95% relative humidity, noncondensing.

Approvals:

Underwriters Laboratories Inc. Component Recognized.
Canadian Underwriters Laboratories Inc. Component Recognized.

Accessories:

50022037-002 AquaReset™ Outdoor Reset Module
C7089U1006 Outdoor Temperature Sensor (used with the 50022037-002)
W8735S1000 (Aquareset™ Outdoor Reset Kit) includes 50022037-002 and C7089U1006)
50022037-005 Domestic Hot Water Module
32003971-003 Temperature Sensor (used with 50022037-005)
W8735S1008 AquaReset™ Domestic Hot Water Kit (includes 50022037-005 and 32003971-003) Sensor (See Table 2).
14,000,485-016 1/4 in. (6.35 mm) diameter, 1-1/4 in. (31.75 mm) long glass cartridge Fuse, 1A, Slow-Blow.
120650 Heat Conductive Compound.
121371AA Sensor Well Clamp.

Table 1. Wells for L7224A,C; L7248A,C,L Controllers.

Part Number	Spud Size in. (mm)	Insertion in. (mm)	Insulation in. (mm)
123869A	1/2 (12.7) NPT	3 (76.2)	1-1/2 (38.1)
123870A	3/4 (19.05) NPT	3 (76.2)	1-1/2 (38.1)

Table 2. Sensors for L7224A,C and L7248A,C,L Controllers.

Part Number	Length in. (mm)	Application
50001464-001	12 (304.8)	Well-mounted controls
50001464-002	18 (457.2)	Flush-mounted controls
50001464-003	24 (609.6)	
50001464-004	36 (914.4)	
50001464-005	48 (1219.2)	

INSTALLATION

When Installing this Product...

1. Read these instructions carefully. Failure to follow them could damage the product or cause a hazardous condition.
2. Check the ratings given in the instructions and on the product to make sure the product is suitable for your application.
3. The installer must be a trained, experienced service technician.



4. After installation is complete, check out product operation as provided in these instructions.
5. Set High Limit, Low Limit and Low Limit Differential to the settings recommended by the boiler OEM.
6. Record the maximum High Limit setting from the replaced controller in the text box provided on the cover insert label.
7. Record the High Limit setting at time of installation in the text box provided on the cover insert label.

⚠ WARNING

Electrical Shock Hazard.
Can cause severe injury, death or property damage.

Disconnect power supply before beginning installation to prevent electrical shock or equipment damage.

Mounting

The L7224A,C and L7248A,C,L models are available in a well-mount, horizontal position, vertical position, or flush mounted remote from the well versions. Dimensions for the variety of mounting options are shown in Fig. 1. Note that each identity will have only a single mounting option.

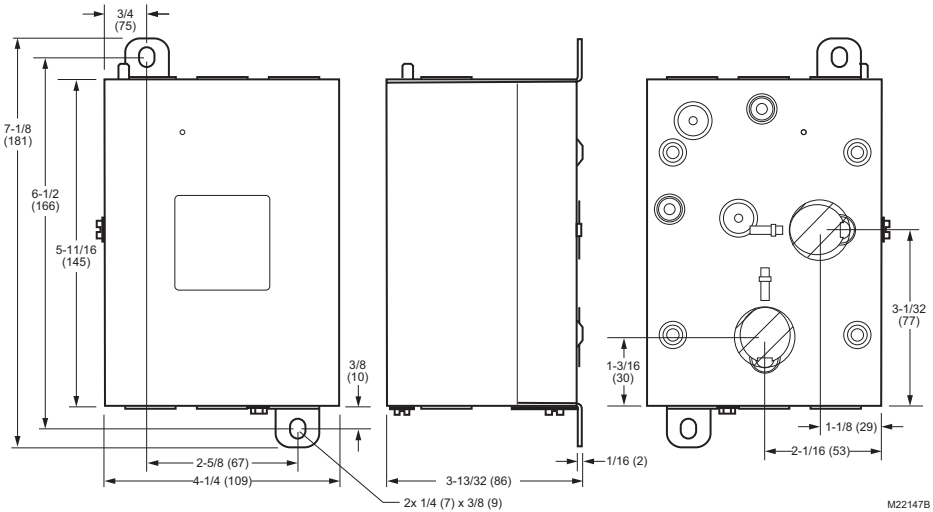

Fig. 1. L7224A,C; L7248A,C,L mounting dimensions in inches (mm).

IMPORTANT

Immersion well must fit sensing element and sensor must rest against bottom of well.

New Installation

Order well assemblies separately; see Table 1 and form no. 68-0040, Immersion Wells and Compression Fittings for Temperature Controllers. Boilers usually have tapings that allow the well to be mounted horizontally so boiler water of average temperature can circulate freely over the well.

1. Turn off all power and drain the boiler.
2. If no tapping is provided, prepare properly sized and threaded tapping near the top of the boiler.
3. Sparingly coat the well threads with pipe dope.

NOTE: Do not attempt to tighten by using the case as a handle.

4. Install the well in the boiler tapping and tighten securely.
5. Refill boiler and check for water leakage.
6. Loosen but do not remove the well clamp screw.
7. Fit the case into the well so the clamp on the case slides over the flange on the well.
8. Securely tighten the clamp screw.
9. Insert the sensor element into the well until it bottoms. See Replacement Sensor Installation section for details. (If necessary, slightly bend the wire inside the case to hold the sensor against the bottom of the well.)
10. Turn power ON.
11. Set High Limit, Low Limit and Low Limit Differential to the settings recommended by the boiler OEM. (See OPERATION section.) (See INSTALLATION steps 6 and 7.)
12. On L7248L models, adjust ELL option to match your configuration (see OPERATION section, and Fig. 12 and 13).

IMPORTANT

Best thermal response is obtained with a well that snugly fits the sensor. Insert the sensor until it rests against the bottom of the well. Use a well of correct length and bend the wiring, if necessary, to hold the bulb against the bottom of the well.

If the well is not a snug fit on the sensor, use the heat-conductive compound (furnished with TRADELINE® models) as follows: Fold the plastic bag of compound lengthwise and twist it gently. Then snip off end of bag and work the open end of the bag all the way into the well. Slowly pull out the bag while squeezing it firmly to distribute compound evenly in the well. Bend the wiring, if necessary, to hold the sensor against the bottom of the well and to hold outer end of the sensor in firm contact with the side of the well. See Fig. 2. Wipe excess compound from the outer end of the well.

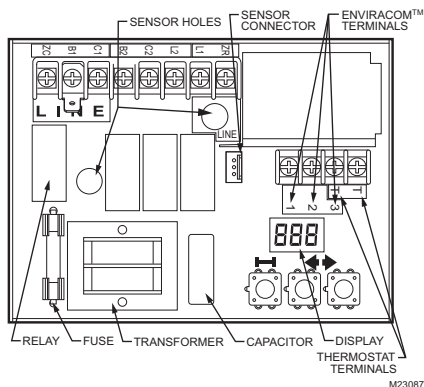

Fig. 3. Circuit board, showing sensor connection and well holes for horizontal mount models.

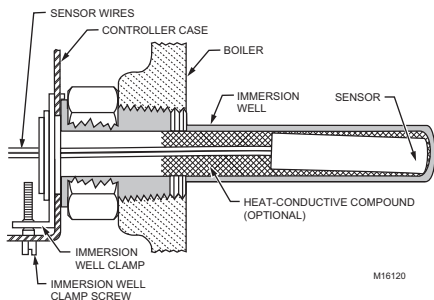

Fig. 2. Position of sensor in immersion well.

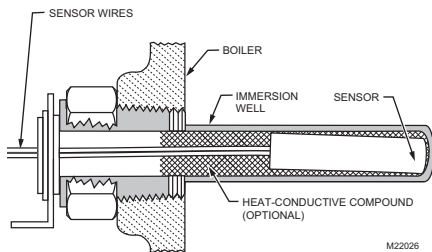

Fig. 4. Replacement sensor installation.

Flush-Mounted Aquastat Replacement

Turn off all power and remove the old control. Refer to the cover insert of the old control to identify and tag each external lead as it is disconnected. If the old well is unsuitable for the new installation, remove it and replace it with a suitable new well. If the old well is suitable, use it.

Well-Mounted Aquastat Replacement

Turn off all power and remove the old control. Refer to the cover insert of the old control to identify and tag each external lead as it is disconnected. If the old well is unsuitable for the new installation, remove it and proceed with instructions for new installation. If the old well is suitable, use it.

1. Loosen, but do not remove, the well clamp screw on the side of the control case.
2. Position immersion well clamp snugly over the flange of the adapter and tighten the clamp screw.
3. Insert the sensor into the well as shown in Fig. 2 or 3. (See Replacement Sensor Installation section for details.)

Replacement Sensor Installation

Turn off all power and:

1. Carefully disconnect sensor from circuit board by pulling gently on the connector.
2. Gently pull sensor from thermo well and through circuit board by pulling on leadwires.
3. Carefully align replacement sensor with hole in circuit board and guide through Aquastat case and into well. (See Fig. 5).
4. Make sure sensor is fully seated to bottom of well (See Fig. 4). Use a small pencil to measure depth of sensor in well, if necessary.
5. Connect sensor to circuit board by pressing connector on sensor unit into mating connector on circuit board (See Fig. 5).
6. For remote sensors (flush-mounted Aquastat Controllers) be sure to use 121571AA Clamp (see Accessories) to securely hold sensor in place.

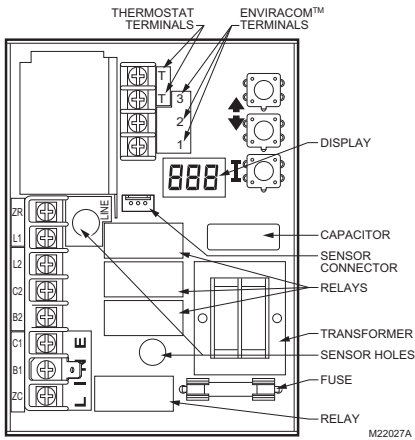

Fig. 5. Circuit board, showing sensor connection and well holes for vertical mount models.

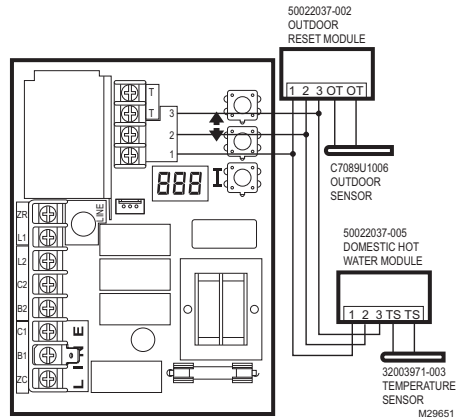

Fig. 6. Wiring the Outdoor Reset Module and the Domestic Hot Water Module.

WIRING

⚠ WARNING

Electrical Shock Hazard.
Can cause serious injury or death.
 Disconnect power supply before making wiring connections to prevent electrical shock or equipment damage.

All wiring must comply with local electrical codes and ordinances. Do not exceed the specifications in the Application section when wiring this control. Use wire rated for 194° F (90° C) or higher.

IMPORTANT

The terminals on these Aquastat Controllers are approved for use with copper wire only.

Follow the appropriate wiring diagrams shown on the inside of the front cover of the L7224A,C; L7248A,C,L or in Fig. 9–13.

Refer to Fig. 6 for Connections for the optional Outdoor Reset Module and the Domestic Hot Water (DHW) module. In subsequent wiring diagrams these modules will be displayed with a dotted line signifying that they are optional.

OPERATION

General

The L7224A,C and L7248A,C,L Oil Electronic Aquastat Controllers are primary safety limit-rated devices designed for use with oil fired boilers with line voltage burners and circulators. Many boilers do not include wiring or control compartments as part of the design, but are provided with an integral, replaceable, immersion well that is the mounting hardware for the Aquastat Controllers. Wiring to the other controls is done through flexible metal conduit.

For boilers that do include a remotely (flush) mounted control, the wiring may be completed with conduit or routed behind the boiler sheet metal.

A separate electromechanical high-limit is not required in a system that uses this control to meet Underwriters Laboratories Inc. requirements for oil-fired boiler assemblies, UL 726.

On the L7224 models, the High Limit, Low Limit, Low Limit Differential, Domestic Hot Water (DHW) Override, and Anti Short-Cycle time can be adjusted to the setting recommended by the boiler OEM. On the L7248 models, the High Limit, Domestic Hot Water (DHW) Override (where applicable), and Anti Short-Cycle time are adjustable, see “Adjusting Settings” on page 5.

The overall range of the High Limit is from 130° F to 240° F (54° C to 116° C). Select devices may have different ranges. Some models have limited ranges on the High Limit setpoint; this limited range is listed on the device label.

Some models also have a Low Limit and Low Limit Differential adjustment. The range of the Low Limit is from 110° F to 220° F (43° C to 104° C). Select devices may have different ranges.

The DHW setting may be switched OFF. The range of the Anti Short-Cycle time is from 10 seconds to five minutes.

If a 50022037-002 AquaReset™ Outdoor Reset Module is installed, the reset curve can be set by entering the minimum outdoor temperature, minimum (boiler) temperature, and maximum outdoor temperature on the 3-digit display. The range of the minimum outdoor temperature is from -40° F to 40° F (-40° C to 4.4° C) and has a default setting of 0° F (-18° C). The range of the maximum outdoor temperature is from 30° F to 70° F (-1.1° C to 21.1° C) and has a default setting of 40° F. The range of the minimum (water or boiler) temperature is from 80° F to 180° F (26.7° C to 82.2° C) and has a default setting of 130° F. See the "Outdoor Reset Module" Installation Instructions (form number 69-2335) for more information on setting the boiler reset curve and all related parameters.

The L7224A,C and L7248A,C,L are designed for use with 24 Vac electronic and electromechanical thermostats and EnviraCOM™ enabled thermostats, and have screw-type terminals for easy field connection.

Adjusting Settings

To discourage unauthorized changing of Aquastat settings, a procedure to enter the **ADJUSTMENT** mode is required. To enter the **ADJUSTMENT** mode, press the **UP**, **DOWN**, and **I** buttons (Refer to Fig. 5) simultaneously for three seconds. Press the **I** button until the feature requiring adjustment is displayed:

- HL_ . High Limit.
- HdF . High Limit Differential.
- LL_ . Low Limit. (L7224A, C)
- LdF . Low Limit Differential (L7224A, C)
- ELL . External Low Limit (L7248L only)
- duu . ZR input configured as external Domestic Hot Water (DHW) request (ON/OFF) (L7224A,C/L7248L)
- ASC . Anti Short-Cycle Timeout (seconds); "OFF" is disabled.
- otL* . Outdoor Temperature Low (minimum) parameter for the outdoor reset curve (°F or °C)
- otH* . Outdoor Temperature High (maximum) parameter for outdoor reset curve (°F or °C)
- btL* . Boiler Temperature Low (minimum) parameter for outdoor reset curve
- bP* . Boost Period (minutes). "OFF" is displayed if Boost is inactive
- bS* . Boost step (°F or °C) shown only if Boost is active (bP=ON)
- UUS* . Warm Weather Shutdown Temperature (°F or °C)
- F-C . Temperature units (°F or °C)

* Settings available for adjustment on the 3-digit display only if the 50022037-002 AquaReset Outdoor Reset Module is installed.

Then press the **UP** and/or **DOWN** buttons to move the set point to the desired value, to change between °F and °C, or to enable (On) or disable (Off) the External Low Limit. After 60 seconds without any button inputs, the control will automatically return to the **RUN** mode.

Display

In the **RUN** mode, the Aquastat will flash "bt" (boiler temp) followed by the temperature (i.e., 220), followed by °F or °C.

To read boiler settings, press the **I** key to read the parameter of interest. For example, press **I** and High Limit (**HL**) is displayed, followed by a three-digit number, i.e., 220, followed by °F or °C. Pressing the **I** button again (on

L7224 models) will display the Low Limit (**LL**) followed by a three-digit number and the corresponding degree designator. See Display Readout, Fig. 6.

After approximately 60 seconds without any key presses, the display will enter a dim display mode. To return to the bright display mode, simply press any key.

Text	Description	Display Shows
<i>Err</i>	Error Code (if one is present)	<i>Err</i>
<i>bt</i>	Boiler Temperature	<i>bt</i>
<i>HL</i>	△ High Limit	<i>HL</i>
<i>HdF</i>	High Limit Differential	<i>HdF</i>
<i>LL</i>	Low Limit (L7224 only)	<i>LL</i>
<i>LdF</i>	Low Limit Differential (L7224 only)	<i>LdF</i>
<i>tt</i>	Local Thermostat Status	<i>tt</i>
<i>ttE</i>	EnviraCOM Thermostat Status	<i>ttE</i>
<i>brn</i>	B1 (Burner) output (ON or OFF)	<i>brn</i>
<i>Cir</i>	C1 (Circulator) output (ON or OFF)	<i>Cir</i>
<i>ZC</i>	ZC (Zone Control) output (ON or OFF)	<i>ZC</i>
<i>Zr</i>	ZR (Zone Request) Call for HEAT (ON or OFF)	<i>Zr</i>
<i>ELL</i>	External Low Limit Enabled (L7248L only)	<i>ELL</i>
<i>duu</i>	ZR Configured as Domestic Hot Water Request (L7224, L7248L only)	<i>duu</i>
<i>ASC</i>	Anti Short-Cycle Timeout	<i>ASC</i>
<i>bSP</i>	△ Boiler Setpoint	<i>bSP</i>
<i>dhc</i>	△ DHW Module Connected (YES or NO)	<i>dhc</i>
<i>ot</i>	△ Outdoor Temperature	<i>ot</i>
<i>otL</i>	△ Outdoor Temperature Low	<i>otL</i>
<i>otH</i>	△ Outdoor Temperature High	<i>otH</i>
<i>btL</i>	△ Boiler Temperature Low	<i>btL</i>
<i>bP</i>	△ Boost Period	<i>bP</i>
<i>bS</i>	△ Boost Step	<i>bS</i>
<i>UUS</i>	△ Warm Weather Shutdown Temperature	<i>UUS</i>
°F	Units are displayed in degrees Fahrenheit	<i>oF</i>
°C	Units are displayed in degrees Celsius	<i>oC</i>
<i>OFF</i>	Input or Output is OFF	<i>OFF</i>
<i>On</i>	Input or Output is ON	<i>On</i>

△ DISPLAY SHOWS LOCAL SETTING; NOT THE SETTING AS MODIFIED BY AN EXTERNAL ENVIRACOM CONTROL.

△ SETTINGS ARE VIEWABLE ONLY IF THE OUTDOOR RESET MODULE AND OUTDOOR TEMPERATURE SENSOR ARE INSTALLED AND FUNCTIONING PROPERLY.

△ SETTINGS ARE VIEWABLE ONLY IF THE DOMESTIC HOT WATER MODULE AND SENSOR ARE INSTALLED AND FUNCTIONING PROPERLY.

M29552

Fig. 7. Display readout definitions.

Operation

The L7224 and L7248 models can be in any of four operational states: Normal, High Limit, Low Limit and Error. The controller moves back and forth from High Limit to Normal to Low Limit state as part of normal operation. Only devices having High Limit settings are restricted to the High Limit and Normal states. However, the controller will enter the Error state when there is an abnormal condition. The operating states are:

1. Normal: Boiler temperature went below the High Limit setting (minus the Differential) and has not exceeded the High Limit setting; or, the boiler temperature went above the Low Limit setting and has not gone below the Low Limit setting (minus the Differential); or, ZR input is not powered with 120 Vac (only L7248L with ELL set On).
2. High Limit: Boiler temperature went above the High Limit setting and has not dropped below the High Limit setting (minus the Differential).
3. Low Limit: Boiler temperature went below the Low Limit setting (minus the Low Limit Differential) and has not gone above the Low Limit setting; or, ZR input is powered with 120 Vac (only L7248L with ELL set On).
4. Error: The controller has detected an error condition (e.g., open sensor) and has shut down the burner output. The ZC output is energized. The controller continues to monitor the system and automatically restarts if the error condition clears. Refer to Table 4.

The operating sequence for the L7224/L7248 is shown in Table 3–6.

High Limit Controller

The High Limit opens and turns off the burner when the water temperature reaches the setpoint. The High Limit automatically resets after the water temperature drops past the setpoint and through the Differential. The L7248 models have High Limit Differential presets of 15° F (8° C). The L7224 models have High Limit Differential presets of 10° F (6° C).

Low Limit and Circulator Controller

On a temperature rise, with the adjustable Differential at the default setting of 10° F (6° C), the burner circuit breaks and the circulator circuit makes (assuming no call for heat is present) at the Low Limit setpoint. On a temperature drop of 10° F (6° C) below the Low Limit setpoint, the burner circuit makes and the circulator circuit breaks. See Fig. 7.

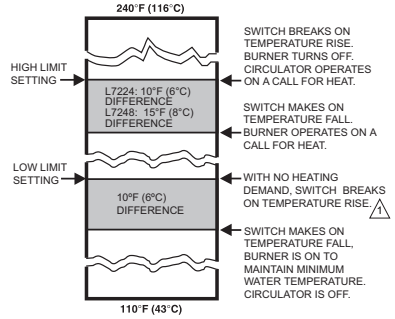

Fig. 8. Setpoints and differentials.

Anti Short-Cycle Feature

The Anti Short-Cycle feature allows for field selection of a delay time between burner cycles. Should a call for heat occur following the end of the previous heat cycle and before the Anti Short-Cycle delay time is expired, the circulator will be allowed to run, but the burner will be held off until the time has elapsed.

NOTE: This feature is blocked if a Domestic Hot Water demand occurs. Domestic Hot Water demands are serviced immediately, without any delay.

NOTE: When the Aquastat is connected to the oil primary and/or thermostat via the EnviraCOM bus, the Anti Short-Cycle time does not apply to recycle events such as loss of airflow or flame. It applies only to loss of demand.

ZR-Domestic Hot Water (DHW) Request

The ZR terminal can be selected to service an indirect water heater heat request. This parameter is set via the 3 digit display (see Adjusting Settings section of this document). A heat request via the ZR terminal will have priority over all other features such as the Anti Short-Cycle feature or those enabled by the Outdoor Reset Module (See form #69-2335 for more information).

CHECKOUT

Put the system into operation and observe at least one complete cycle to make sure that the controller operates properly. See TROUBLESHOOTING section to use LED to assist in determining system operation.

TROUBLESHOOTING

When attempting to diagnose system performance, reference to the LED display can help to identify specific areas not working properly. The LED display will scroll **Err**, followed by a digit (1-8). Refer to Table 7 and 8 for a description of each error and suggested actions.

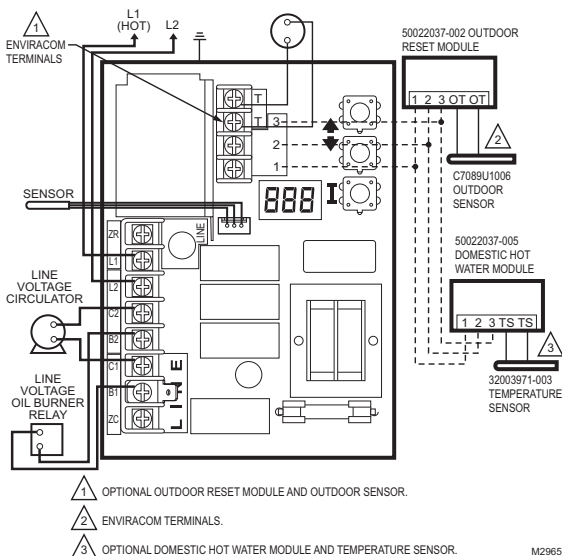

Fig. 9. L7224A,C; L7248A,C,L single zone connections.

Table 3. L7224/L7248 Controller Operating Sequence.

Action	System Response
Thermostat calls for heat.	Circulator starts when water temperature is above Low Limit setting (if applicable). Boiler temperature is checked. Burner starts when water temperature is below High Limit setting. If Anti Short-Cycle Time is enabled, the burner does not start until the set Anti Short-Cycle Time between cycles expires after the previous call for heat was satisfied.
Boiler temperature exceeds the High Limit.	Burner is turned off. Burner restarts when the water temperature drops below the High Limit setting minus the Differential.
Thermostat is satisfied.	Circulator and burner turn off.
Boiler temperature drops below the Low Limit setting minus the differential (if applicable).	Burner is turned on, Circulator is turned off. Burner stops when the water temperature exceeds the Low Limit setting.
Error condition 1-5.	If an error condition is detected, all outputs except ZC are shut down. Burner is off. Control continues to function and restarts when error is corrected. During the error check sequence, the system checks for drift in the sensor and corrosion in the connections.
Error condition 6.	EnviraCOM communication is not available.
Error condition 7.	The control has reset the High Limit, Low Limit and Differential setting to a default setting and will continue to run at those settings. Performance of the system will be degraded.
Error condition 8.	If the error condition is detected, all outputs except ZC are shut down. Burner is off. Control continues to function and restarts when all three user keys have been pressed longer than 60 seconds.
Error condition 9*.	System continues to run with no outdoor reset functionality
Error condition 10*.	System continues to run with outdoor reset parameters enabled as programmed. Error cleared automatically.
Error condition 11*.	System continues to run with boiler temp set to High Limit.

* Error condition only available when the Outdoor Reset Module is installed.

Table 4. L7224/L7248 Controller Operating Sequence with multiple zones connected through the ZR terminal.

Action	System Response
Zone Request (ZR) terminal is connected to L1 (Zone calls for heat).	Boiler temperature is checked. Burner starts when water temperature is below High Limit setting. Anti Short-Cycle Time is applied, see Table 3A.
Boiler temperature exceeds the High Limit.	Burner is turned off. Burner restarts when the water temperature drops below the High Limit setting minus the Differential.
Zone Request input is de-energized (Zones are satisfied).	Burner turns off.
Boiler temperature drops below the Low Limit setting minus the differential (if applicable).	Burner turns on and Zone Control is de-energized. Burner turns off and Zone Control is re-energized when the water temperature exceeds the Low Limit setting.

Table 5. Controller Operating Sequence with External Low Limit device connected through the ZR terminal.

Action	System Response
Zone Request (ZR) terminal is connected to L1 (External Low Limit call for heat).	Boiler temperature is checked. Burner starts when water temperature is below High Limit setting. Circulator turns off.
Boiler temperature exceeds the High Limit.	Burner is turned off. Burner restarts when the water temperature drops below the High Limit setting minus the Differential.
Zone Request input is de-energized (External Low Limit is satisfied).	Burner is turned off.

Table 6. L7224 Controller Operating Sequence with Domestic Hot Water connected through the ZR terminal.

Action	System Response
Zone Request (ZR) terminal is connected to L1 (Domestic Hot Water calls for heat).	Boiler temperature is checked. Burner starts when water temperature is below High Limit setting.
Boiler temperature exceeds the High Limit.	Burner is turned off. Burner restarts when the water temperature drops below the High Limit setting minus the Differential.
Zone Request input is de-energized (Domestic Hot Water is satisfied).	Burner is turned off.

Table 7. LED Error Codes.

Aquastat Error Code	Cause/Action	EnviraCOM Alarm
Err1	Aquastat sensor fault; check water sensor.	18
Err2	ECOM fault; check EnviraCOM™ wiring.	18
Err3	Excessive electrical noise or frequency out of range. Hardware fault; replace controller.	18, 58
Err4	B1 fault; check B1 wiring/voltage.	64
Err5	Low Line; check L1-L2, 110 Vac.	59
Err6 ^a	Warning: Fuse; check ECOM wires, replace fuse.	92
Err7	Warning: EEPROM, HL, LL, Hdf, Ldf; reset to default values.	N/A
Err 8 ^b	Repeated B1 fault (voltage present at B1 when output is turned off); check B1 wiring/voltage.	25
Err9 ^a	Warning: Outdoor Reset System failure; communication to Outdoor Reset Module lost, Outdoor Reset Module failure, multiple outdoor temperature sensors detected on the bus, or outdoor temperature sensor failure. Check EnviraCOM wiring (1, 2, 3), check sensor wiring.	50, 53, 149
Err 10 ^a	Warning: Boost Failure; Boost Mode active at least once per cycle for the last 60 consecutive cycles. Check Outdoor Reset curve settings.	150
Err 11 ^a	DHW Module/Sensor failure; communication to DHW Module lost, DHW Module failure, or temperature sensor failure. Check EnviraCOM wiring (1, 2, 3), check sensor wiring.	146, 147, 148

^a Warnings are generated to enunciate the system is not operating optimally, but the Aquastat is still operating and maintaining boiler temperature. In the instance where an Outdoor Reset Module is used, the warnings may indicate a reset curve setting error one or more features is not running optimally, and the Aquastat is reverting to default settings or has stopped running the Outdoor Reset algorithms. The warnings are cleared when the issue(s) is resolved.

^b To clear Err 8 condition, depress and hold all three user keys simultaneously for 60 seconds. Err 8 condition clears and display returns to normal. Err 8 condition is designed to catch welded relays on the Aquastat and will normally only occur near end of life for the control. If Err 8 condition has occurred early in the controls life, be sure to check for voltage feedback to B1 when B1 should be off and check current draw on b terminal to be sure oil burner is not drawing excessive current. Err 8 condition will keep repeating if B1 fault is not cleared.

Table 8. Troubleshooting Guide

System Condition	Diagnostic Condition	Check	Action
Boiler is cold, house is cold.	Display is OFF. Display is ON.	120 Vac System power.	Turn system power on.
		24 Vac T-T	No 24 V; replace control.
		24 V present; disconnect thermostat, short T-T.	Boiler starts, check wiring and thermostat.
		120 Vac at B1-B2	<ul style="list-style-type: none"> If no, replace control. If yes, check burner and wiring.
		Refer to Err on display.	—
Boiler is hot, house is cold.	Display is ON.	120 Vac at C1-C2	<ul style="list-style-type: none"> 120 Vac at C1-C2, check wiring to pump. Wiring OK, is pump running? If not, replace the pump. If pump is running, check for trapped air or closed zone valves.
		Boiler below the Low Limit temperature, wait for boiler to go above Low Limit temperature.	—
		Boiler above LL? If yes, check for 120 Vac between ZC and L2.	<ul style="list-style-type: none"> If no 120 Vac, replace control. If yes, check zone relays, circulators and wiring.
		ELL setting (L7248L only)	<ul style="list-style-type: none"> Set ELL to Off for multizone system (see Fig. 12). Set ELL to On for External Low Limit (see Fig. 13).
		Boiler above LL? If yes, check 120 Vac at ZR-L2 (only L7248L with ELL set On)	<ul style="list-style-type: none"> If no 120 Vac, check C1-C2 (see above). If yes, check the External Low Limit control.
Boiler is hot, no hot potable water.			<ul style="list-style-type: none">

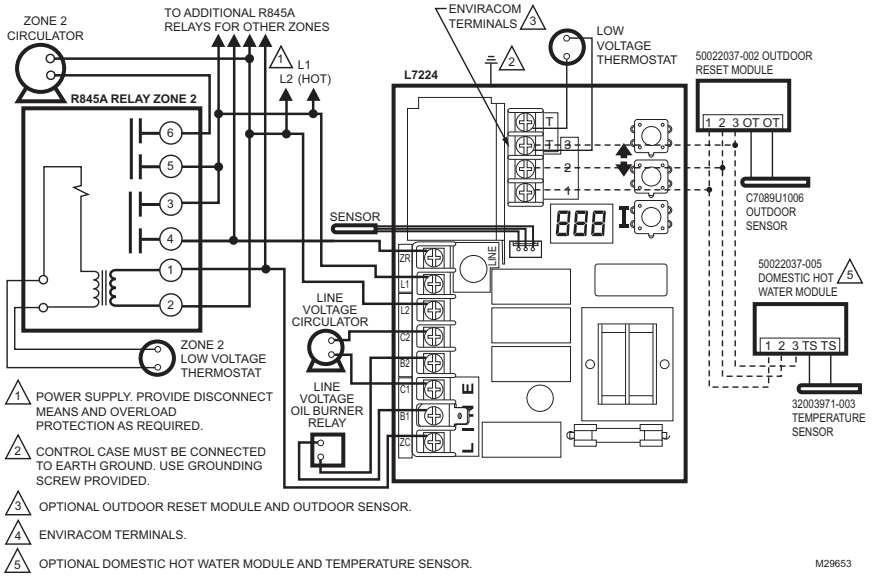

Fig. 10. L7224A,C multizone system with circulator connections.

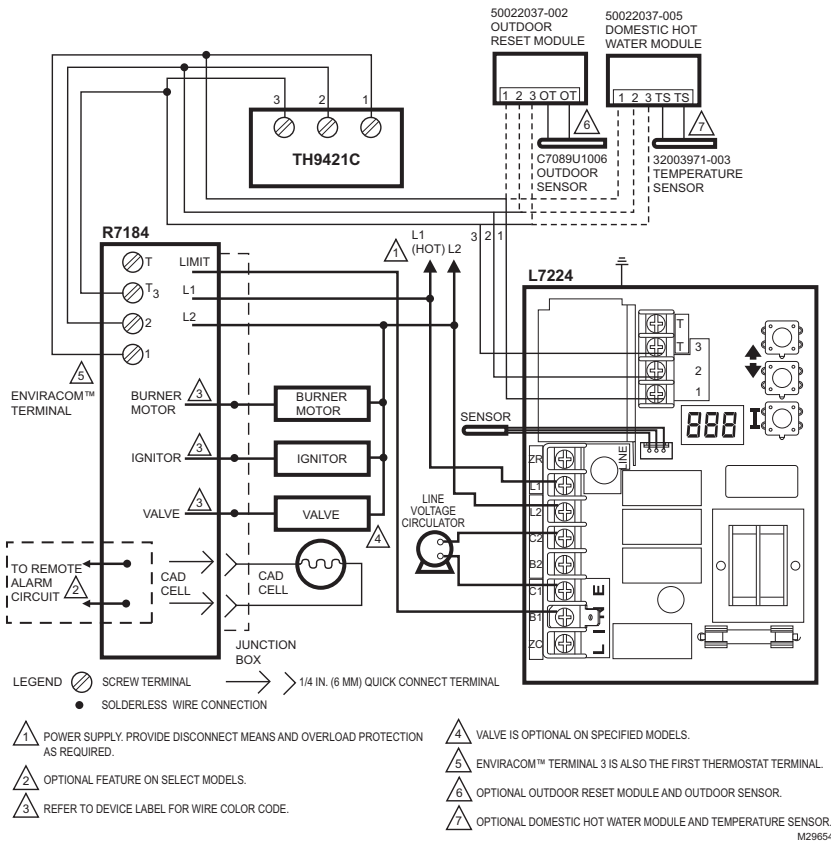

Fig. 11. L7224A,C multizone system with circulator connections and EnviraCOM™ thermostat.

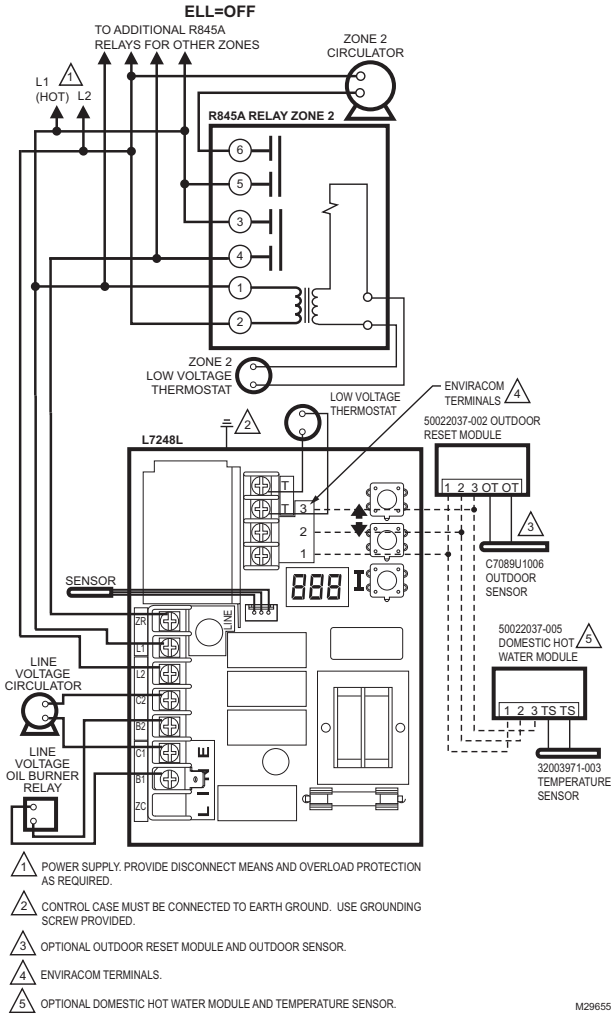

Fig. 12. L7248L multizone system with circulator connections.

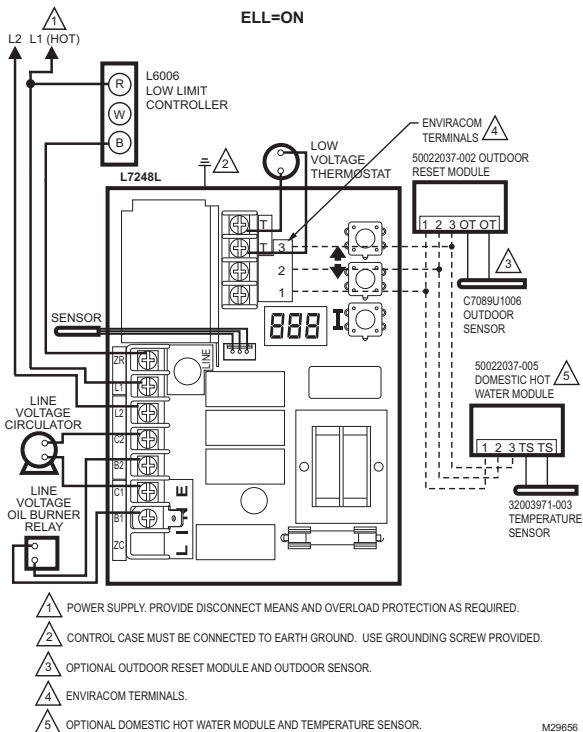

Fig. 13. L7248L External Low Limit connections.

Automation and Control Solutions

Honeywell International Inc.
1985 Douglas Drive North
Golden Valley, MN 55422
customer.honeywell.com

Honeywell Limited-Honeywell Limitée
35 Dynamic Drive
Toronto, Ontario M1V 4Z9

® U.S. Registered Trademark
© 2009 Honeywell International Inc.
68-0281—05 M.S. Rev. 08-09



Printed in U.S.A. on recycled
paper containing at least 10%
post-consumer paper fibers.

Honeywell